

Manual for Telos LRF



Specifications

You can learn more about the main parameters [here](#).

| | |
|--------------------------------|-----------------|
| Model | LRF XP50 |
| SKU | 77492 |
| Microbolometer | |
| Type | uncooled |
| Resolution, Pixels | 640x480 |
| Pixel Pitch, μm | 17 |
| NETD, mK | < 18 |
| Frame Rate, Hz | 50 |
| Optical Characteristics | |

| | |
|---|---|
| Optical Magnification, x | 2.5 |
| Smooth Digital Zoom | 2.5-10 |
| Digital Zoom, x | x1 - x4 |
| Lens Focus, mm | 50 |
| Relative Aperture, D/f' | 1.0 |
| Minimum Focus Distance, m/y | 5 / 5.5 |
| Exit Pupil Diameter, mm/inch | 4 / 0.16 |
| Angular Field of View (Horizontal x Vertical), degree | 12.4x9.3 |
| Linear Field of View, m at 100 m | 21.8 |
| Eyepiece Focus Range, Dioptr | +4 / -5 |
| Detection Distance for Deer-Sized Objects, m/y | 1800 / 1969 |
| Display | |
| Type | AMOLED |
| Resolution, Pixels | 1024x768 |
| Operational Characteristics | |
| Power Supply, V | 3 - 4.2 |
| Battery Type/Capacity/Nominal Output Voltage | LPS7i Li-ion Battery Pack / 6400 mAh / DC 3.7 V |
| External Power Supply | 5 V, 9 V (USB Type-C) |
| Battery Run Time at t=22°C, hours* | 8.5 |
| Degree of Protection, IP Code (IEC60529) | IPX7 |
| Operating Temperature Range, °C / °F | -25 ... +40 / -13 – +104 |

| | |
|---|----------------------------|
| Dimensions, mm/inch | 238x72x90 / 9.37x2.83x3.54 |
| Weight (with battery), kg/oz | 0.72 / 25.4 |
| Video Recorder | |
| Photo/Video Resolution, Pixels | 1024x768 |
| Video/Photo Format | .mp4 / .jpg |
| Built-in Memory | 64 GB |
| Wi-Fi Channel** | |
| Frequency | 2.4/5 GHz |
| Standard | IEEE 802.11 b/g/n/ac |
| Characteristics of the Rangefinder | |
| Wavelength, nm | 905 |
| Measurement Range, m/y*** | 1000/1094 |
| Measurement Accuracy, m | 1 |

* Actual operating time depends on the extent of using Wi-Fi, integrated video recorder and integrated laser rangefinder.

** Reception range may vary depending on various factors: obstacles, other Wi-Fi networks.

*** Depends on the characteristics of the object under observation and environmental conditions.

About the device

Description

Telos LRF thermal imaging monoculars are designed for use both at night-time and during the day and provide exceptional image quality even in

adverse weather conditions (fog, smog, rain) and beyond obstacles like branches, tall grass, dense foliage, etc. known to hinder target detection.

Unlike night-vision devices based on electron-optical converters, thermal imaging devices do not need an external light source and are resistant to bright light.

Telos LRF thermal imagers are designed for various applications including hunting, observation, security, terrain orientation, search and rescue operations, etc.

Telos LRF thermal imagers are equipped with a built-in laser rangefinder with a range of up to 1000 m and a measurement accuracy of ± 1 m.

To get started, see the sections:

[Battery Charging](#)

[Battery Installation](#)

[Powering on and Image Setting](#)

[Laser Rangefinder](#)

[Stream Vision 2](#)

[Package Contents](#)

- Telos LRF thermal imager
- LPS7i battery pack with protective cover
- Spare battery compartment cover
- Power adapter
- USB Type-C cable with USB Type-A adapter
- Case
- Hand strap
- Quick start guide

- Lens cloth
- Warranty card



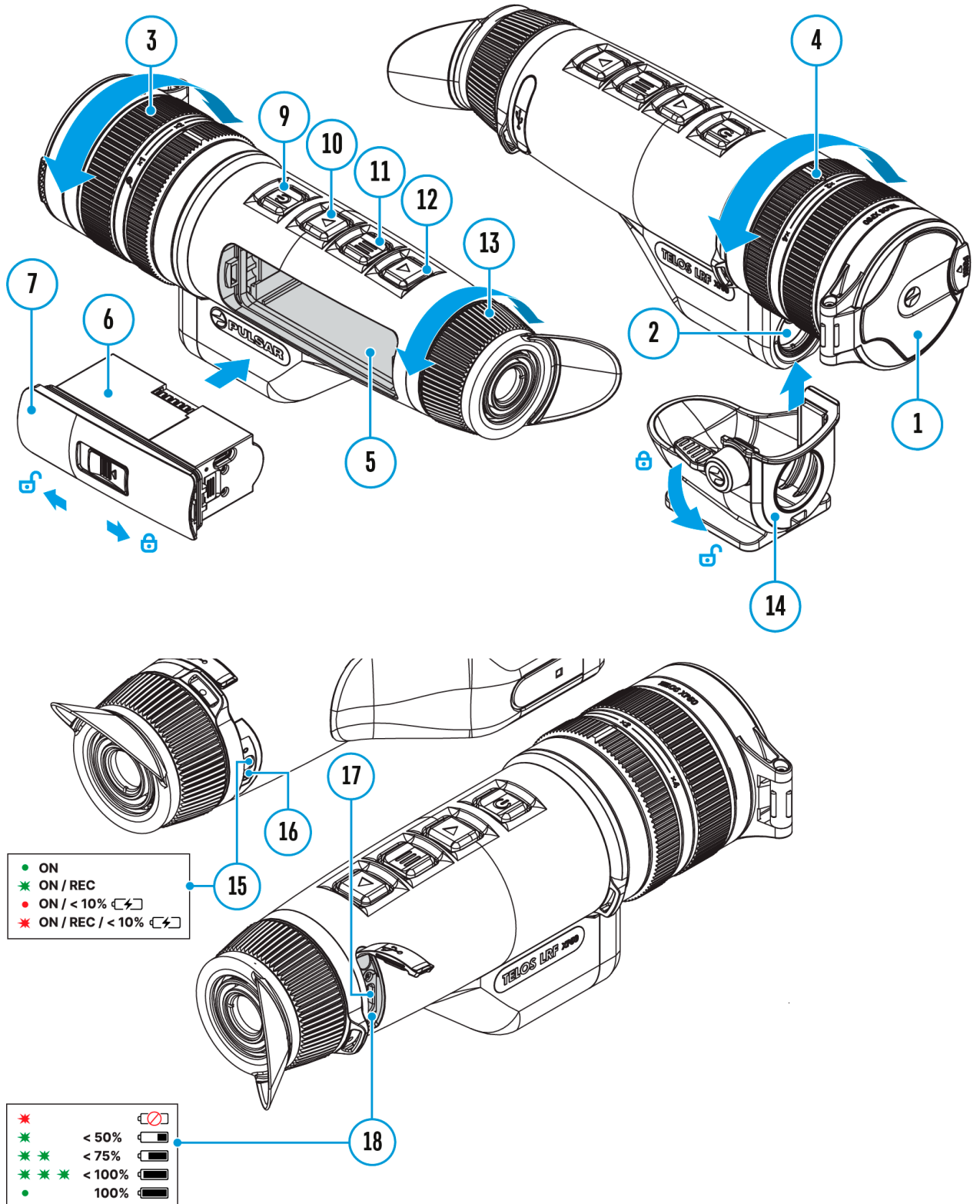

Components and Controls



1. Lens cover
2. Laser rangefinder

3. Lens focus ring
4. Digital zoom adjustment ring
5. Battery compartment
6. LPS7i battery
7. Battery compartment cover
8. Battery protective cover
9. ON/OFF/Calibration button
10. UP/REC button
11. MENU button
12. DOWN/LRF button
13. Eyepiece diopter adjustment ring
14. Tripod adapter (available separately)
15. Operation status LED indication
16. Microphone
17. USB Type-C connector
18. LED indication of battery charge in the device

LED indicator **(15)** displays the current status of the device:

| LED Indicator | Operating Mode |
|---|--|
|  | Device is turned on |
|  | The device is turned on/video recording |
|  | The device is turned on/battery charge < 10% |
|  | The device is turned on/video recording/battery charge < 10% |

Features

- Compact and lightweight

- Functional and ergonomic design
- 8-colour display palette
- 3 calibration modes: Manual, Semi-Automatic, Automatic
- Detection range up to 1800 m/1969 yds
- Smooth digital zoom 2.5-10x
- Three levels of sensitivity enhancement: Normal, High, Ultra
- Integrated laser rangefinder
- Display-Off function
- Defective pixel repair
- Updatable firmware
- Wide operating temperature range (-25°C to +40°C / -13°F to +104°F)
- Fully waterproof (IPX7 rated)

Video/Audio Recording

- Built-in video and sound recorder
- Integration with iOS and Android devices
- Wi-Fi remote control and viewing using a smartphone
- Storing photos and videos in Cloud when using the Stream Vision 2 App

Battery Pack

- Quick Change Li-Ion Battery Pack LPS7i
- Charging from USB Power Bank
- Quick-Charge power delivery

Power supply

Precautions

- It is not recommended to charge the battery with the USB cable and wireless charger at the same time. This will not increase the charge rate and may damage the battery.
- Use the USB Type-C cable and power adapter supplied with the device (or purchased separately) to charge the LPS 7i batteries.
- Follow the safety precautions described in its Manual when using the wireless charger.

- Do not place any foreign objects between the battery and wireless charger platform.
- Do not charge the battery immediately after bringing it from cold to warm. Wait at least 30 minutes for the battery to warm up.
- Do not leave the battery unattended while charging.
- Do not use the power adapter and wireless charger if they have been modified or damaged.
- Do not leave the battery plugged in after charging is complete.
- Do not expose the battery to high temperatures and naked flame.
- Do not use the battery as a power source for devices that do not support LPS 7i batteries.
- Do not disassemble or deform the battery.
- Do not drop or strike the battery.
- Do not submerge the battery.
- Keep the battery out of the reach of children.

Recommendations for Battery Use

- The battery should be partially charged (50 to 80 %) for long-term storage.
- Charge at an ambient temperature of 0°C to +35°C (32°F to 95°F) or the lifespan of the battery will decrease significantly.
- Using the battery at sub 0°C (<32°F) ambient temperature decreases battery capacity. This is normal and not a defect.
- Using the battery at temperatures outside the range of -25°C to +50°C (-13°F to 122°F) may reduce battery life.
- The battery is short-circuit protected. Any situation that may cause short-circuiting should be avoided.

Battery Charging

The **Telos LRF** thermal imager comes with an LPS7i rechargeable Lithium-ion battery. LPS7i batteries support USB Power Delivery fast charging technology when using a standard charging set (USB Type-C cable, power adapter). Before first use, make sure the battery is fully charged. LPS 7i batteries also support wireless charging.



The icon  in the status bar will flash when the battery is low. The battery needs to be charged.

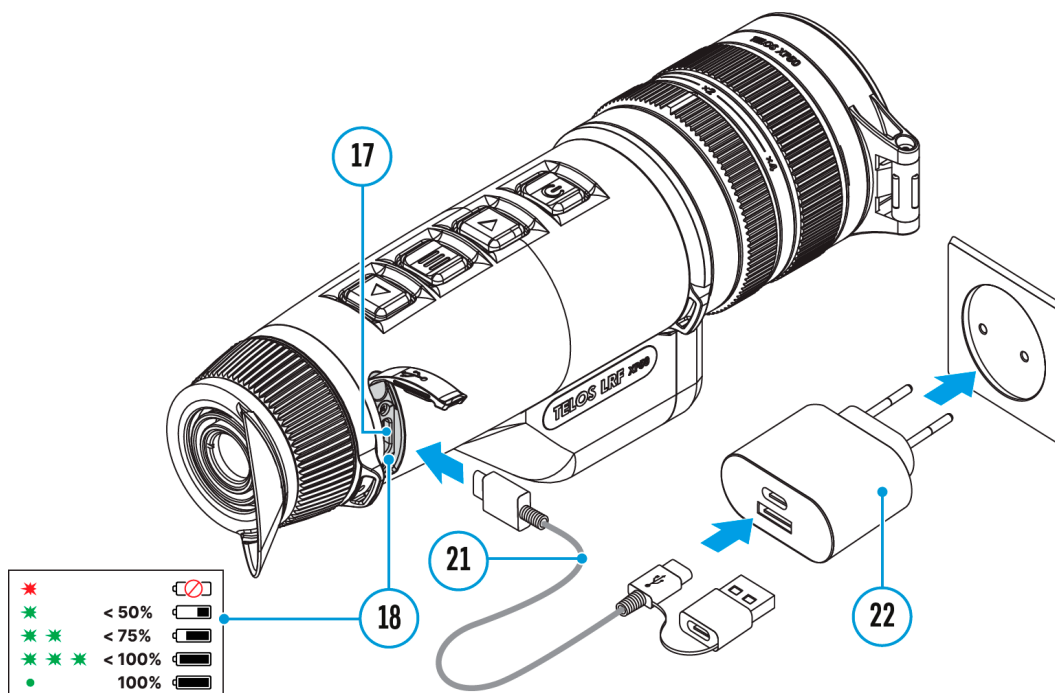

Option 1. USB Charging



1. **Install** the LPS7i battery in the battery compartment of the device.
2. Connect the USB cable (21) to the USB Type-C connector (17) of the device.
3. Connect the other end of the USB cable (21) to the Power Adapter (22) by removing the USB Type-A adapter.
4. Plug the Power Adapter (22) into a 100-240 V socket.
5. Wait until the battery is fully charged (indication in the status bar: ).

If the device is off, the LED indicator (18) will display the battery charge status:

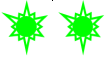
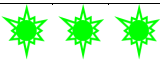

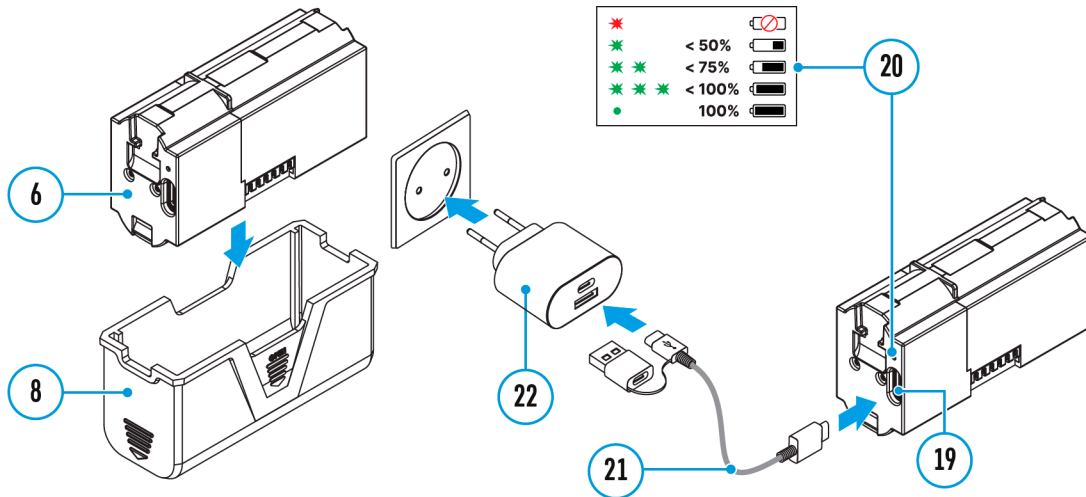

| LED indication | Battery charge status |
|---|--|
|  | Battery defective. Do not use the battery! |
|  | Battery charge level is from 0% to 50% |

| | |
|---|---|
|  | Battery charge level is from 51% to 75% |
|  | Battery charge level is from 76% to 99% |
|  | Battery is full |

Option 2. Charging the battery via USB



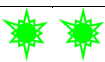

1. Remove the protective cover **(8)**.
2. Connect the plug of the USB Type-C cable **(21)** to the USB Type-C connector **(19)** of the battery.
3. For fast charging, connect the second end of the USB Type-C cable **(21)** to the Type-C connector of the power adapter **(22)** by removing the Type-A adapter from the plug. When connected to a computer or a Type-A power adapter, the battery will charge at normal speed.
4. Plug the power adapter **(22)** into a 100-240 V socket.
5. LED **(20)** will display battery charge level (see Table).

| LED indication | Battery charge status |
|---|--|
|  | Battery defective. Do not use the battery! |
|  | Battery charge level is from 0% to 50% |
|  | Battery charge level is from 51% to 75% |
|  | Battery charge level is from 76% to 99% |

| | |
|---|-----------------|
| ● | Battery is full |
|---|-----------------|

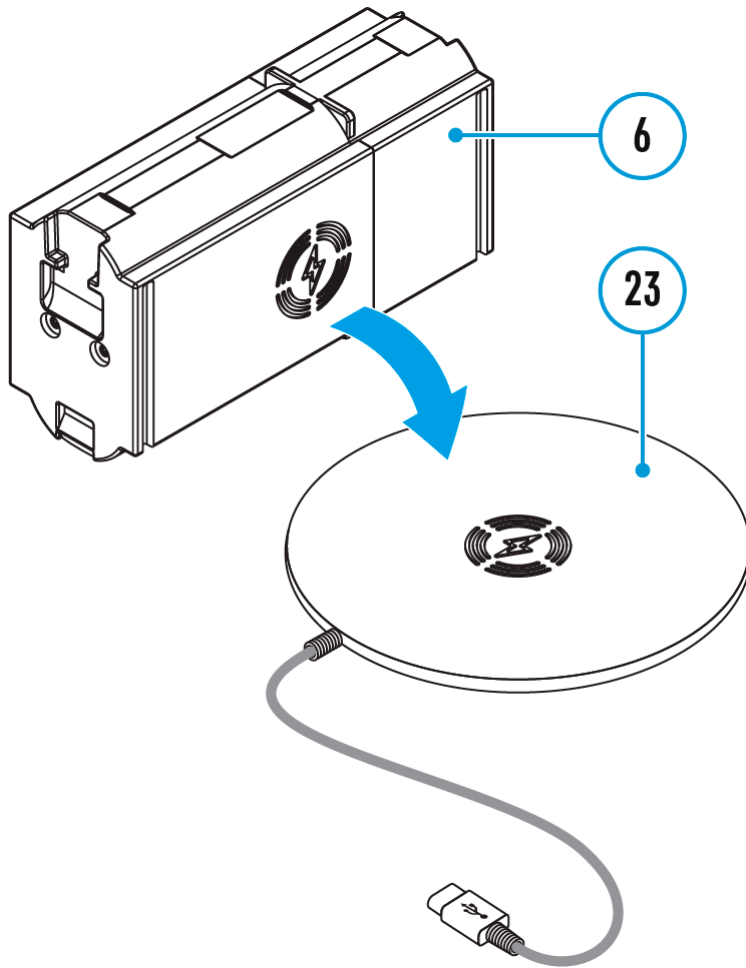
Option 3. Wireless Charging



1. Place the battery **(6)** with the sign  side on the wireless charger* **(23)**. For more efficient wireless charging, align the lightning bolt icon on the battery with the centre of the charger platform **(23)**.
2. Turn on the wireless charger according to its instruction manual.
3. LED **(20)** will display battery charge level (see Table).

* Third party-purchasing. The LPS7i battery works with all Qi standard wireless chargers.

Battery Installation

1. Install the cover **(7)** on the LPS7i battery **(6)**.

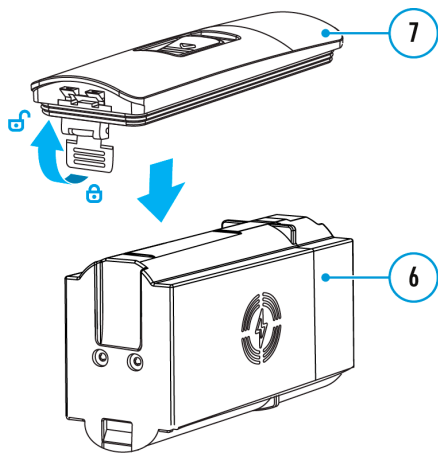

2. Insert the battery (6) into the battery compartment (5) until you hear a click. The battery contacts must face the top of the device (see diagram).

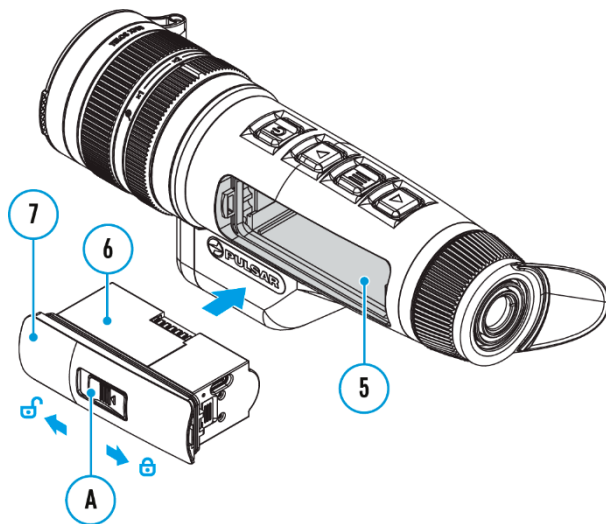

3. To remove the battery (6), slide the switch (A) on the cover (7) to the left .

External Power Supply

Power can be supplied from an external source such as a 5 V or 9 V power bank.





1. Connect the external power source to the USB Type-C connector (17) on the device.
2. The device will switch to draw power from the external source while the LPS7i battery is gradually recharged.
3. A battery icon  will appear on the display showing the percentage-charged level.

- An icon  will be displayed when the device is powered by an external power source and the LPS7i battery is not connected.
 - The device automatically switches to the LPS7i battery when the external power supply is disconnected.
-

Attention! Charging LPS7i batteries from an external source at temperatures below 0°C (<32°F) can reduce battery life. When using external power, connect the power bank to the device only after it has been turned on and working (warming) for at least several minutes.

Getting Started

Powering on and Image Settings









- Open the lens cover **(1)**.
- Press the **ON/OFF (9)** button briefly to turn on the device.
- Adjust the eyepiece diopter ring **(13)** until the symbols in the display are sharp.
- Rotate the lens focus ring **(3)** to focus on the object being observed.
- To change the magnification, turn the digital zoom adjustment ring **(4)**.
- Enter the main menu with a long press of the **MENU (11)** button and select the desired **calibration mode**: manual (M), semi-automatic (SA) or automatic (A).
- Calibrate the image by briefly pressing the **ON/OFF (9)** button (if the SA or M calibration mode has been selected). Close the lens cover when calibrating manually.
- Activate the quick menu by briefly pressing the **MENU (11)** button to adjust the brightness and contrast of the display and select the desired **amplification level** (“Normal” , “High” , “Ultra” ) (for more details see the **Quick Menu** section).
- Activate the **smoothing filter**  in the main menu to improve the image as the amplification level increases.
- Select one of the colour palettes in the main menu (for more details see the **Colour Modes** section).















11. Upon completion of use turn the device off by a long press of the **ON/OFF (9)** button.





Observation conditions: time of day, weather, type of observation objects affect the image quality. Custom settings for brightness, display contrast as well as the function of adjusting the microbolometer sensitivity amplification level will help to achieve the desired quality in a particular situation.

Warning! Never point the lens at intensive energy sources such as laser radiation emitting devices or the sun. It can damage electronic components in the device. The warranty does not cover damage arising from failure to comply with operating instructions.

Button Operation

| Operation | Button |
|------------------------------------|---|
| Power device on |  short press |
| Power device off |  long press for 3 secs |
| Turn display off |  long press for less than 3 secs |
| Turn display on |  short press |
| Calibrate the microbolometer |  short press |
| Turn on/off the White Hot palette |  long press |
| Video Recorder | Button |
| Start/pause/resume video recording |  short press |
| Stop video recording |  long press |

| | |
|---|---|
| Switch to video / photo |  long press |
| Capture a photo |  short press |
| Laser Rangefinder | Button |
| Turn on rangefinder |  short press |
| Single distance measurement |  short press |
| Activate rangefinder scan mode |  long press |
| Deactivate rangefinder scan mode |  short press |
| Turn off rangefinder |  long press |
| Main Menu | Button |
| Enter main menu |  long press |
| Navigation upwards/rightwards |  short press |
| Navigation downwards/leftwards |  short press |
| Confirm selection |  short press |
| Exit submenu without confirming selection |  long press |
| Exit menu (switch to viewing mode) |  long press |
| Quick Menu | Button |
| Enter quick menu |  short press |

| | |
|-----------------------------------|---|
| Switch between quick menu options |  short press |
| Increase value |  short press |
| Decrease value |  short press |
| Exit quick menu |  long press |

Interface

Status Bar



The status bar at the bottom of the display shows current operating statuses via icons, including:

- Colour Mode:

 - White hot

 - Black hot

- Amplification level
- Smoothing Filter (displayed when the function is on)
- Calibration Mode (in Automatic calibration mode a countdown timer  00:03 will appear instead of the calibration mode icon 3 seconds before automatic calibration begins).
- Microphone
- Magnification
- Wi-Fi Connection
- Time
- Power Indication:

 - charge level if the device is powered by a battery

 - charge level if the device is charging and powered by a battery

—■= - no battery, the device is connected to an external power supply

Quick Menu

The quick menu is used to quickly access the settings for brightness, contrast, and amplification modes.



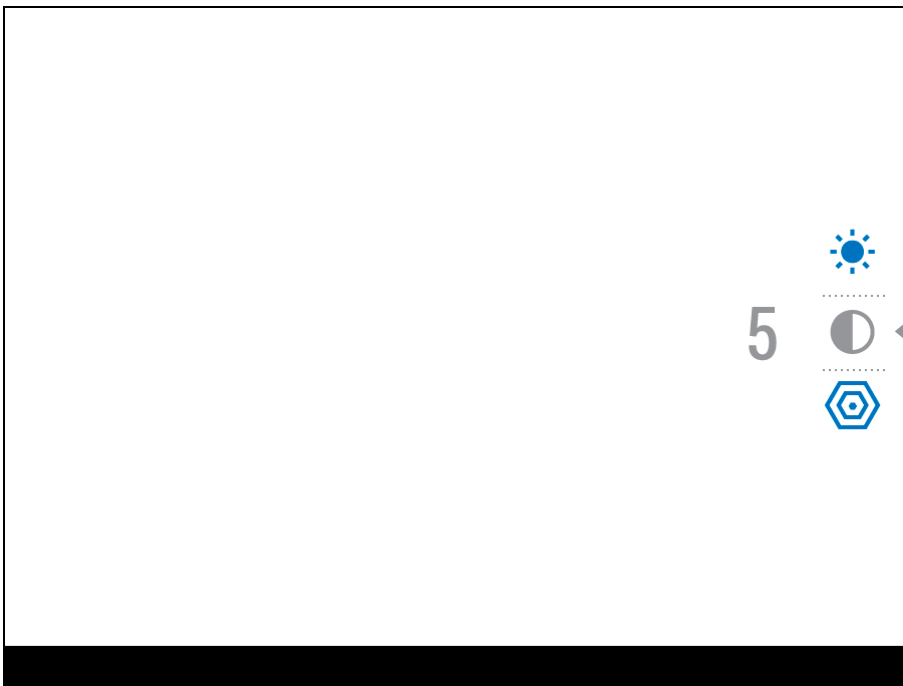

- Enter the menu by briefly pressing the **MENU (11)**.
- A short press of the **MENU (11)** button enables you to toggle between functions, as described below.



Brightness ☀️ – press the **UP (10)/DOWN (12)** buttons to change display brightness from 0 to 20.

Contrast 🌑 – press the **UP (10)/DOWN (12)** buttons to change image contrast from 0 to 20.

Note: display brightness and contrast settings are saved in the memory when the device is turned off.

Amplification Levels  – allows you to select one of three **amplifying levels of sensitivity** (Normal , High , Ultra ).

Note: To maintain brightness and contrast settings when changing amplifying levels, activate **User Mode**.

- Press and hold the **MENU (11)** button to exit the menu or wait for 10 seconds to exit automatically.

Main Menu

Enter the Main Menu

1. Enter the main menu with a long press of the **MENU (11)** button.
2. Press the **UP (10)/DOWN (12)** buttons to move through the menu items.
3. Press the **MENU (11)** button briefly to select the menu item.
4. Press and hold the **MENU (11)** button to exit the menu or wait for 10 seconds to exit automatically.
5. Automatic exit takes place after 10 seconds of inactivity.

Note: When entering the main menu, the background image darkens to enhance the menu visibility. This is normal and not a defect.

General View of Menu

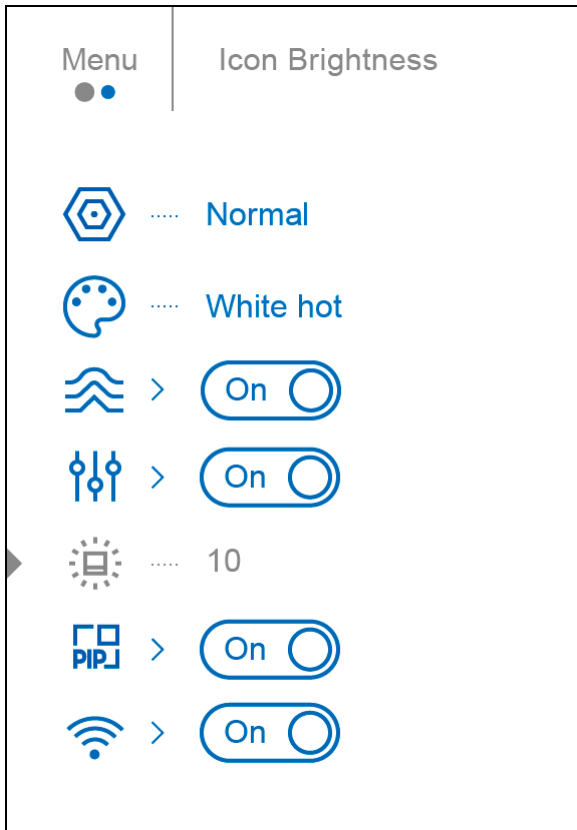

Tab 1

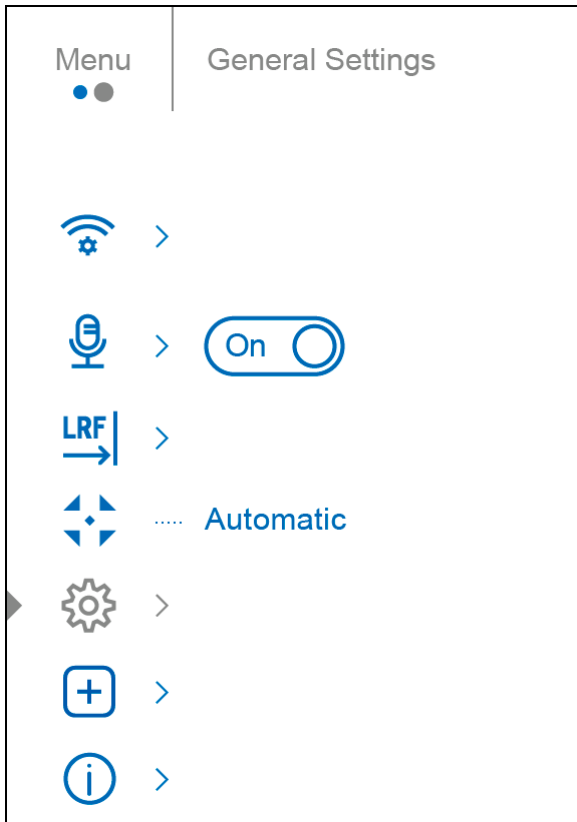

Tab 2







Amplification Level





The Normal , High , Ultra  sensitivity enhancement features are the latest in software algorithm offerings from Pulsar that enhance the quality of detection and object recognition, regardless of observation conditions. When the temperature contrast decreases due to conditions such as fog, precipitation or high humidity, increasing the amplification level can optimize the image picture.

To reduce digital distortion, activate the **Smoothing Filter** in the main menu.

Quick Menu:

1. Enter the quick menu by briefly pressing the **MENU (11)** button.
2. Briefly press the **MENU (11)** button to select the **Amplification Level**  icon.
3. Use the **UP (10)/DOWN (12)** buttons to select one of three amplifying levels of sensitivity (Normal , High , Ultra ).
4. Press and hold the **MENU (11)** button to exit the menu or wait for 10 seconds to exit automatically.

Main Menu:

1. Press and hold the **MENU (11)** button to enter the main menu.
2. Use the **UP (10)/DOWN (12)** buttons to select the **Amplification Level**  icon.
3. Press the **MENU (11)** button briefly to enter the Amplification Level submenu.
4. Use the **UP (10)/DOWN (12)** buttons to select one of three amplifying levels of sensitivity (Normal , High , Ultra ).
5. Press the **MENU (11)** button briefly to confirm the selection.

Colour Modes



Colour palette selection.

White Hot is the default display mode.

To select an alternative palette, do the following:

1. Press and hold the **MENU (11)** button to enter the main menu.
2. Use the **UP (10)/DOWN (12)** buttons to select **Colour Modes**  icon.
3. Press the **MENU (11)** button briefly to enter the submenu.
4. Use the **UP (10)/DOWN (12)** buttons to select the desired palette.
5. Press the **MENU (11)** button briefly to confirm the selection.

Note: you can also switch from a selected color palette to the **White hot** palette with a long press of the **DOWN (12)** button.

Tip: to preserve brightness and contrast values when switching palettes, activate **User Mode**.

- **Black Hot** - a black and white palette where white = cold; black = hot
- **Red Hot**
- **Red Monochrome**
- **Rainbow**

- **Ultramarine**
 - **Violet**
 - **Sepia**
-

Attention! The device should not be used to accurately measure temperature. The images generated are based on temperature contrast rather than true temperature readings.

Smoothing Filter

Used to reduce digital distortion while maintaining a high level of sensitivity.

1. Press and hold the **MENU (11)** button to enter the main menu.
2. Use the **UP (10)/DOWN (12)** buttons to select the **Smoothing Filter**  icon.
3. Press the **MENU (11)** button briefly to turn the filter on/off.

User Mode

The User Mode function saves selected brightness and contrast settings in the device's memory providing optimal image quality for the next use of the thermal imager immediately, with no additional adjustments needed.

1. Press and hold the **MENU (11)** button to enter the main menu.
2. Use the **UP (10)/DOWN (12)** buttons to select the **User Mode**  icon.
3. Press the **MENU (11)** button briefly to turn the mode on/off.

Icon Brightness

Adjust brightness level of the icons and screensavers (Pulsar, Display off) on the display.

1. Press and hold the **MENU (11)** button to enter the main menu.
2. Use the **UP (10)/DOWN (12)** buttons to select the **Icon Brightness**  icon.
3. Press the **MENU (11)** button briefly to enter the submenu.
4. Use the **UP (10)/DOWN (12)** buttons to select the desired brightness level from 0 to 10.
5. Press the **MENU (11)** button briefly to confirm the selection.

PiP Mode

Picture in Picture mode

1. Press and hold the **MENU (11)** button to enter the main menu.
2. Use the **UP (10)/DOWN (12)** buttons to select the **PiP Mode**  icon.
3. Press the **MENU (11)** button briefly to turn on/off.

Wi-Fi Activation

Turning Wi-Fi on/off

1. Press and hold the **MENU (11)** button to enter the main menu.
2. Use the **UP (10)/DOWN (12)** buttons to select the **Wi-Fi Activation**  icon.
3. Press the **MENU (11)** button briefly to turn Wi-Fi on/off.

Wi-Fi Settings

This item enables you to set up your device for operation in a Wi-Fi network.

1. Press and hold the **MENU (11)** button to enter the main menu.
 2. Use the **UP (10)/DOWN (12)** buttons to select the **Wi-Fi Settings**  icon.
 3. Press the **MENU (11)** button briefly to enter the submenu.
-

Password Setup

This function enables you to set a password to access the scope from an external device. The password is used to connect an external device (i.e. smartphone) to your thermal imager.

1. Press the **MENU (11)** button briefly to enter the **Password Setup**  submenu.
 2. The default password (**12345678**) will appear on the screen.
 3. Use the **UP (10)/DOWN (12)** buttons to set the desired password using the **UP (10)** button to increase and the **DOWN (12)** button to decrease the values.
 4. Press the **MENU (11)** button to toggle between the digits.
 5. Press and hold the **MENU (11)** button to save your password and exit the submenu.
-

Access Level Setup

This option allows you to configure the appropriate access level to your device made available to the Stream Vision 2 application.

- **Owner** level. A Stream Vision 2 user has full access to all device functions.
 - **Guest** level. A Stream Vision 2 user only has access to the real time video stream from the device.
1. Press briefly the **MENU (11)** button to enter the **Access Level Setup**  submenu.
 2. Select the access level with the **UP (10)/DOWN (12)** buttons.
 3. Press and hold the **MENU (11)** to confirm your selection and exit from the submenu.
-

Wi-Fi Band

This setting helps to solve smartphone connection issues in the following cases:

- If your smartphone does not support 5 GHz Wi-Fi band, switch to 2.4 GHz.
 - Many Wi-Fi networks cause interference. In this case, switching between Wi-Fi bands can improve the connection between the device and the smartphone.
1. Press briefly the **MENU (11)** button to enter the **Wi-Fi Band**  submenu.
 2. Press the **UP (10)/DOWN (12)** buttons to select the WiFi bandwidth – **5 GHz** or **2.4 GHz**.
 3. Confirm your selection with a short press of the controller **MENU (11)** button.

Microphone

Turning microphone on/off

This item allows you to enable (or disable) the microphone for recording sound during video recording.

1. Press and hold the **MENU (11)** button to enter the main menu.
2. Use the **UP (10)/DOWN (12)** buttons to select **Microphone**  icon.
3. Press the **MENU (11)** button briefly to turn on/off.

The microphone is off by default.

Rangefinder

Menu item Rangefinder contains settings for the built-in laser rangefinder.

1. Press and hold the **MENU (11)** button to enter the main menu.
2. Select the submenu **Rangefinder**  with the **UP (10)/DOWN (12)** buttons.
3. Press the **MENU (11)** button briefly to enter the submenu.

Reticle Type

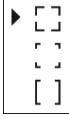
1. Press the **MENU (11)** button briefly to enter the **Reticle Type**  submenu.
 2. Select one of the three reticle shapes  with the **UP (10)/DOWN (12)** buttons.
 3. Confirm selection with a brief press of the **MENU (11)** button.
-

TPA

This feature allows you to determine the target position angle. When the function is activated the angle is constantly displayed in the upper right corner of the display.

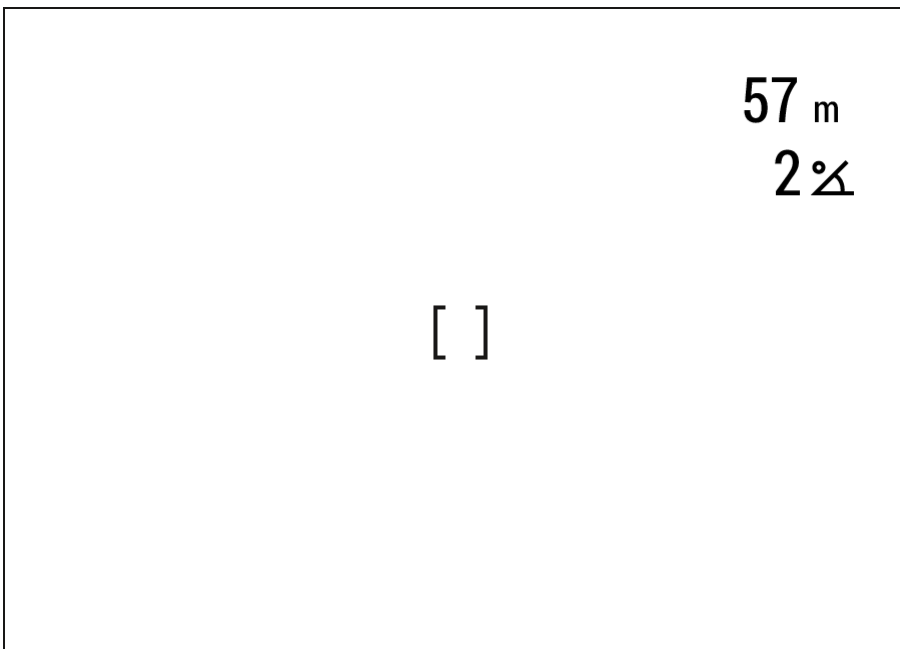

1. Select **TPA**  with the **UP (10)/DOWN (12)** buttons.
 2. Turn **TPA** on/off with a short press of the **MENU (11)** button.
-

THD

"THD" (True Horizontal Distance) function allows you to measure true horizontal distance to a target based on the angle of elevation value.

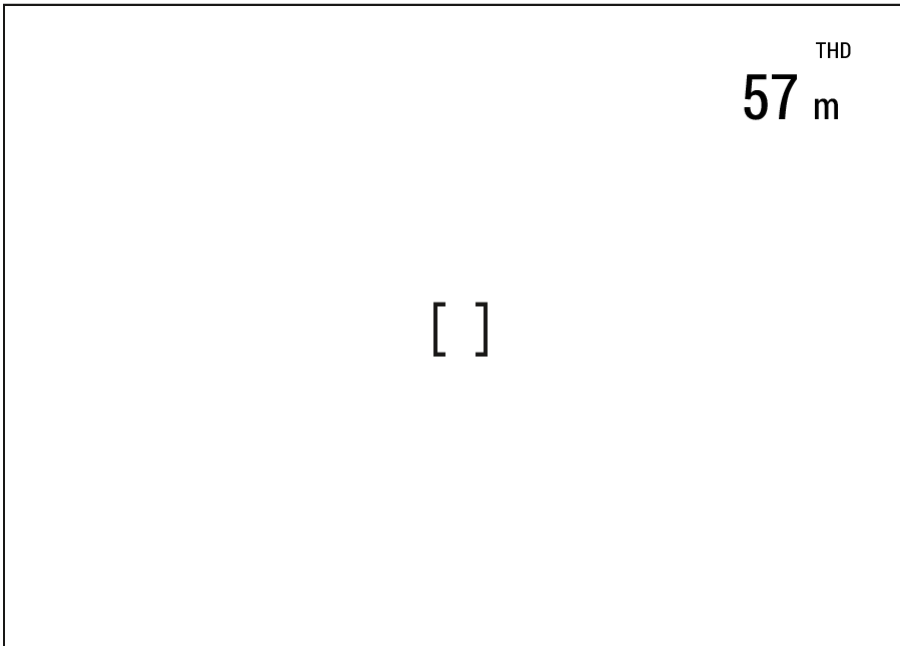

1. Select **THD**  with the **UP (10)/DOWN (12)** buttons.
2. Turn THD on/off with a short press of the **MENU (11)** button
3. Hereinafter the message *THD* will appear above the distance readings.

Calibration Mode

Calibration mode selection.

Calibration enables the device to equalize the microbolometer background temperature and eliminate the image flaws (such as vertical bars, phantom images, etc.).

There are three calibration modes: **Manual**, **Semi-Automatic** and **Automatic**.

The selected calibration mode is displayed in the status bar (see [Status Bar](#) section).

Select the required mode in the Calibration Mode menu item:

1. Press and hold the **MENU (11)** button to enter the main menu.
 2. Use the **UP (10)/DOWN (12)** buttons to select the **Calibration Mode**  icon.
 3. Press the **MENU (11)** button briefly to enter the submenu.
 4. Use the **UP (10)/DOWN (12)** buttons to select one of the calibration modes described below.
 5. Press the **MENU (11)** button briefly to confirm the selection.
-

M mode (Manual)

- Close the lens cover **(1)**.
- Press the **ON/OFF (9)** button briefly.
- Open the lens cover **(1)** after the calibration is completed.

SA mode (Semi-Automatic)

- The user independently determines the need for calibration (according to the image being observed).
- Press the **ON/OFF (9)** button briefly to activate calibration.
- There is no need to close the lens cover because an internal shutter covers the microbolometer automatically.

A mode (Automatic)

- The device is calibrated autonomously according to firmware algorithms.
- There is no need to close the lens cover because an internal shutter covers the microbolometer automatically.
- In this mode, the user can still choose to calibrate the device using the **ON/OFF (9)** button if required (as in the **SA** mode).

Note: during calibration, the image on the display briefly freezes for up to 1 second.

General Settings

This menu section allows you to change the interface language, set the date, time, units of measure, return the device to factory default settings and perform memory card formatting.

1. Press and hold the **MENU (11)** button to enter the main menu.
 2. Use the **UP (10)/DOWN (12)** buttons to select the **General Settings**  icon.
 3. Press the **MENU (11)** button briefly to enter the submenu.
 4. Choose the required menu item with **UP (10)/DOWN (12)** buttons.
-

Language

Language selection

1. Press the **MENU (11)** button briefly to enter the **Language**  menu item.
 2. Use the **UP (10)/DOWN (12)** buttons to select one of the available interface languages: English, German, Spanish, French, Russian, Italian, Portuguese, Dutch, Danish, Norwegian, Swedish, Polish, Czech, Hungarian.
 3. Press the **MENU (11)** button briefly to confirm the selection.
 4. Press and hold the **MENU (11)** button to save your selection and exit from the submenu.
-

Date

Date setting

1. Press the **MENU (11)** button briefly to enter the **Date**  menu item. The date is displayed in dd/mm/yyyy format.
2. Use the **UP (10)/DOWN (12)** buttons to select the desired year, month, and date. Press the **MENU (11)** button briefly to toggle between digits.

3. Press and hold the **MENU (11)** button to save the date and exit the submenu.
-

Time

Time setting

1. Press the **MENU (11)** button briefly to enter the **Time**  menu item.
 2. Select the time format (24-hour clock or AM / PM) by pressing the **UP (10)/DOWN (12)**.
 3. Press the **MENU (11)** button to select the hours.
 4. Press the **UP (10)/DOWN (12)** buttons to select the hour value.
 5. Press the **MENU (11)** button to select the minutes.
 6. Press the **UP (10)/DOWN (12)** buttons to select the minute value.
 7. Press and hold the **MENU (11)** button to save the time and exit the submenu.
-

Units of Measure

Rangefinder units of measure

1. Press the **MENU (11)** button briefly to enter the **Units of Measure**  menu item.
 2. Press the **UP (10)/DOWN (12)** buttons to select either Meters or Yards as the unit of measure.
 3. Press the **MENU (11)** button briefly to confirm your selection.
 4. Exit from the submenu will happen automatically.
-

Video Compression

When set to ON, standard video compression is applied so the video file size is reduced.

When set to OFF, minimal video compression is applied. In this case, the quality of the recorded video is better, but its size is significantly increased.

Warning! Larger video file sizes result in shorter recording times. This may lead to longer download times for video files through the Stream Vision 2 app.

Enable/disable video compression:

1. Select the **Video Compression**  menu item with the **UP (10)/DOWN (12)** buttons.

2. To turn on video compression, briefly press the **MENU (11)** button. 

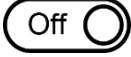
3. To turn off video compression, briefly press the **MENU (11)** button. 

Default Settings

Factory reset

1. Press the **MENU (11)** button briefly to enter the **Default Settings**  menu item.
2. Use the **UP (10)/DOWN (12)** buttons to select Yes to restore default settings or *No* to cancel.
3. Confirm your selection with a short press of the **MENU (11)**
 - If *Yes* is selected, display will show "*Do you want to restore default settings?*" with *Yes* and *No* dialogue options. Select *Yes* to restore the default settings.
 - Selecting the *No* option will cancel the reset and exit the submenu.

The following settings will be returned to their defaults before being changed by the user:

- **Video Recorder Mode** – Video
- **Amplification Level** – Normal
- **Smoothing Filter** – Off
- **User Mode** - Off
- **Calibration Mode** – Automatic
- **Language** – English
- **Microphone** - off
- **Wi-Fi** – Off (default password)
- **PiP** – Off
- **Colour Mode** – White Hot
- **Units of Measure** – Meters
- **Video Compression** – On
- **Wi-Fi Band** – 5 GHz

Attention! When restoring the factory defaults the date, time and user pixel map are saved.

Format

This function enables you to format the Flash memory card. All files will be deleted.

Formatting should be carried out in case of a memory card error.

Before formatting, make sure you transfer all footage to other media.

1. Press the **MENU (11)** button briefly to enter the **Format** .
2. Use the **UP (10)/DOWN (12)** buttons to select *Yes* to format the memory card or *No* to return to the submenu.

3. Press the **MENU (11)** button briefly to confirm your selection.
 - If “Yes” is selected, display will show “Do you want to format memory?” with “Yes” and “No” dialogue options. Select Yes to format the memory card.
 - Selecting the *No* option will cancel the formatting and exit the submenu.

Defective Pixel Repair

Defective Pixel Repair

When using the device, defective (dead) pixels may appear on the microbolometer. These are bright or dark points of constant brightness that are visible on the image.

Defective pixels on the microbolometer can increase in size relative to the digital-zoom power.

Telos LRF thermal monoculars allows the user to remove any defective pixels on the display, as well as cancel removal, via the device’s firmware.

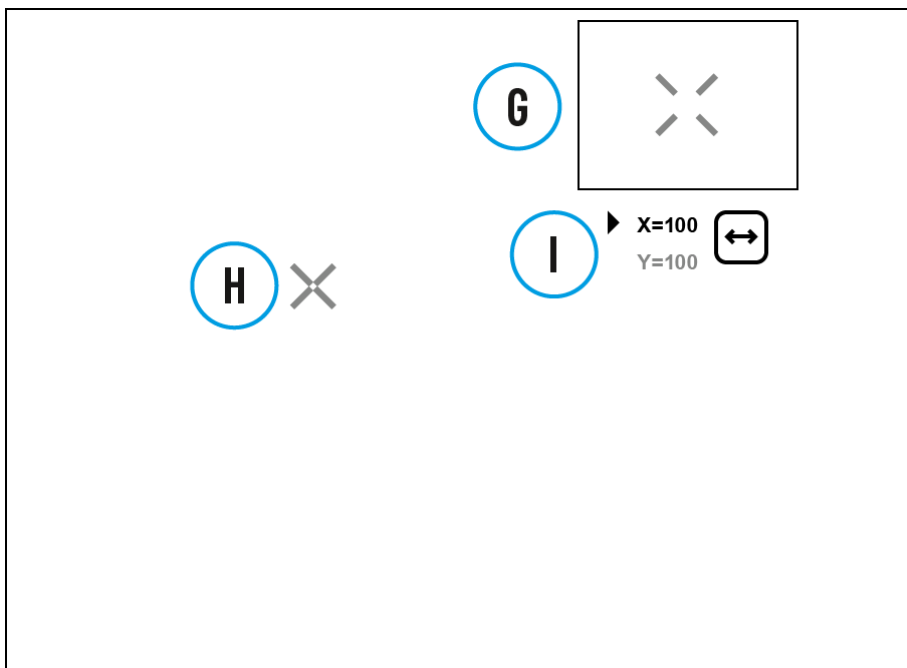



Step 1. Enter the menu to fix the defective pixels

1. Press and hold the **MENU (11)** button to enter the main menu.
2. Use the **UP (10)/DOWN (12)** buttons to select the **Defective Pixel Repair**  menu item.

3. Press briefly the **MENU (11)** to open the submenu.
 4. Select the **Defective Pixel Repair**  option by briefly pressing the **MENU (11)** button.
-

Step 2. Select the defective pixel

1. A marker **(H)**  appears on the left side of the display.
 2. On the right side of the display appears a "magnifying glass" **(G)** - a magnified image in the frame with a fixed cross , designed for easier detection of a defective pixel and to match the pixel with the marker, and horizontal and vertical arrows for X and Y axes **(I)** showing the marker's movement.
 3. With a short press of the **UP (10)/DOWN (12)** buttons move the marker to align it with a defective pixel.
 4. Switch the direction of the marker from horizontal to vertical and vice versa with a short press of the **MENU (11)** button.
 5. Align the defective pixel with the fixed cross in the frame - the pixel should disappear.
-



Step 3. Remove the defective pixel

1. Delete the defective pixel with a short press of the **ON/OFF (9)**.
 2. Once the pixel has been successfully deleted an "OK" message will briefly appear on the screen.
 3. You can then delete another defective pixel by moving the marker across the display.
 4. Exit the Defective Pixel Repair submenu with a long press of the **MENU (11)**.
-

Warning! The display of a thermal imager may have 1- 2 pixels represented as bright white or coloured (blue, red) dots which cannot be deleted and are not a defect.

Restore Default Pixel Map

This option allows the user to return all previously disabled defective pixels to their original state.

1. Press and hold the **MENU (11)** button to enter the main menu.
2. Use the **UP (10)/DOWN (12)** buttons to select the **Defective Pixel Repair**  icon.
3. Press the **MENU (11)** button to enter the submenu.
4. Use the **UP (10)/DOWN (12)** buttons to select the **Restore Default Pixel Map**  icon.
5. Activate the function by briefly pressing the **MENU (11)**.
6. Using the **UP (10)/DOWN (12)** buttons, select *Yes* if you want to return to the factory pixel map and select *No* if you do not.
7. Confirm your selection with a short press of the **MENU (11)**.

Device Information

This menu item allows the user to view the following information about the device:

- SKU Number
- Firmware Version
- Device Name
- Hardware Version
- Device Serial Number
- Service Information

To display information, do the following:

1. Press and hold the **MENU (11)** button to enter the main menu.
2. Use the **UP (10)/DOWN (12)** buttons to select the **Device Information**  icon.
3. Press the **MENU (11)** button briefly to view/exit the information.

Functions

Video Recording and Photography

Telos LRF thermal imagers are capable of video recording and photography. Videos and images are saved on the built-in memory card.



Before using this feature please set the **date** and **time** (see **General Settings** section).

For information on how to watch recorded photos and videos, see the Stream Vision 2 user manual: **Android**, **iOS**.

The built-in recorder operates in two modes – **Video** and **Photo**.

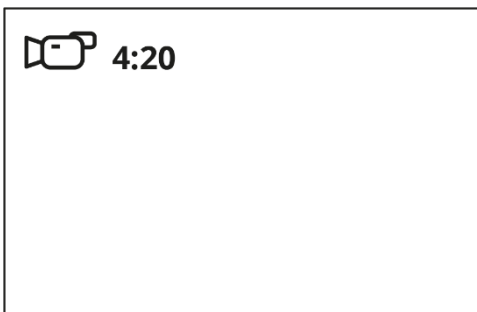
Video mode. Video recording



1. Switch to **Video** mode by pressing and holding the **UP/REC (10)** button.
2. The  icon and the remaining recording time in HH:MM (Hours:Minutes) format are displayed in the upper left corner, for example 4:20.
3. Press the **UP/REC (10)** button briefly to start video recording.
4. When the video recording starts, the icon  will disappear and the REC icon and timer in MM:SS (Minutes:Seconds) format will appear  REC | 00:25 .

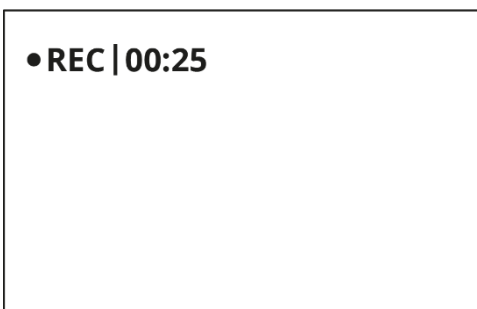

5. Pause and resume recording video with a short press of the **UP/REC (10)** button.
 6. Stop recording video with a long press of the **UP/REC (10)** button.
 7. Video files are saved to the built-in memory card after the video recording has been stopped.
 8. Press and hold the **UP/REC (10)** button to switch between the **Video** and **Photo** modes (Video-> Photo-> Video...)
-

Photo Mode. Capturing an image



1. Switch to the **Photo** mode by pressing and holding the **UP/REC (10)** button.
 2. Press the **UP/REC (10)** button briefly to take a photo. The icon  flashes – the photo file is being saved to the built-in SD card.
-

Notes:

- You can enter and operate the menu during video recording.
- Recorded videos and photos are saved to the internal memory card in the format img_xxx.jpg (photos), video_xxx.mp4 (videos).
- Videos are recorded in clips with a maximum duration of 5 minutes. The number of recorded files is limited by the capacity of unit's internal memory and video compression ratio.
- Regularly check the free capacity of the internal memory and move recorded footage to other storage media to free up space on the internal memory card.

- In case of a memory card error, you can use the format function in the **General Settings** section of the main menu.
- When the **Display Off** function is activated, video recording continues to run in the background.

Laser Rangefinder

The **Telos LRF** thermal imager is equipped with an integrated laser rangefinder.

Single Measurement Mode

1. Press the **ON/OFF (9)** button briefly to power the device on.
2. Activate the rangefinder by pressing the **DOWN/LRF (12)** button briefly. A red mark appears on the display.
3. Place the rangefinder's reticle on the target. Press the **DOWN/LRF (12)** button briefly to measure the distance to the object once.
4. The measurement results are displayed in the upper right corner.

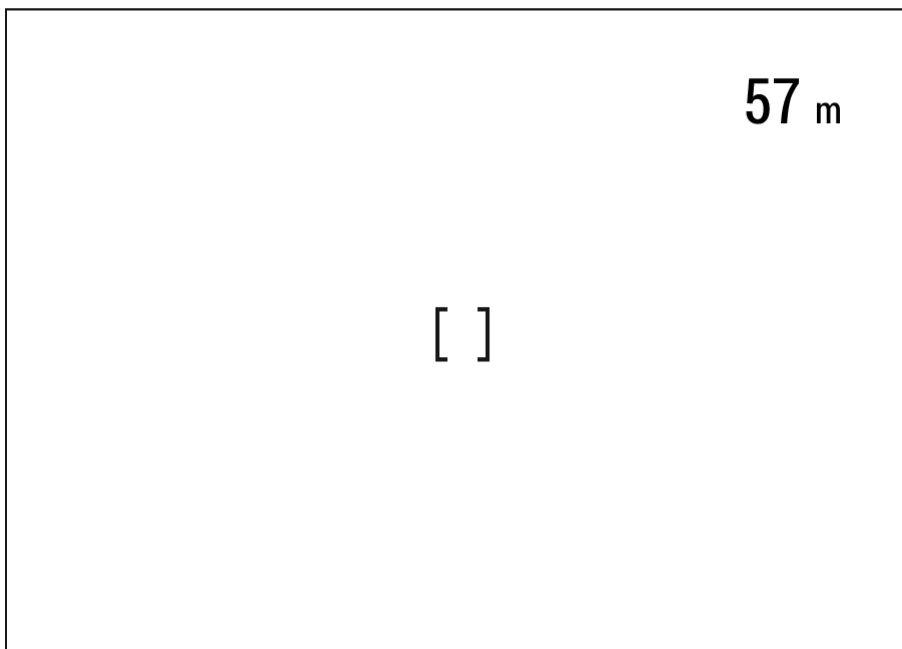

5. The rangefinder shuts down after 3 seconds of inactivity.
-

Scan Mode

1. Press the **ON/OFF (9)** button briefly to power the device on.
2. Activate the rangefinder by pressing the **DOWN/LRF (12)** button briefly. A red mark appears on the display.
3. Activate the scan mode by long pressing the **DOWN/LRF (12)** button to continuously measure the distance to objects.
4. The measurement results are displayed in the upper right corner.

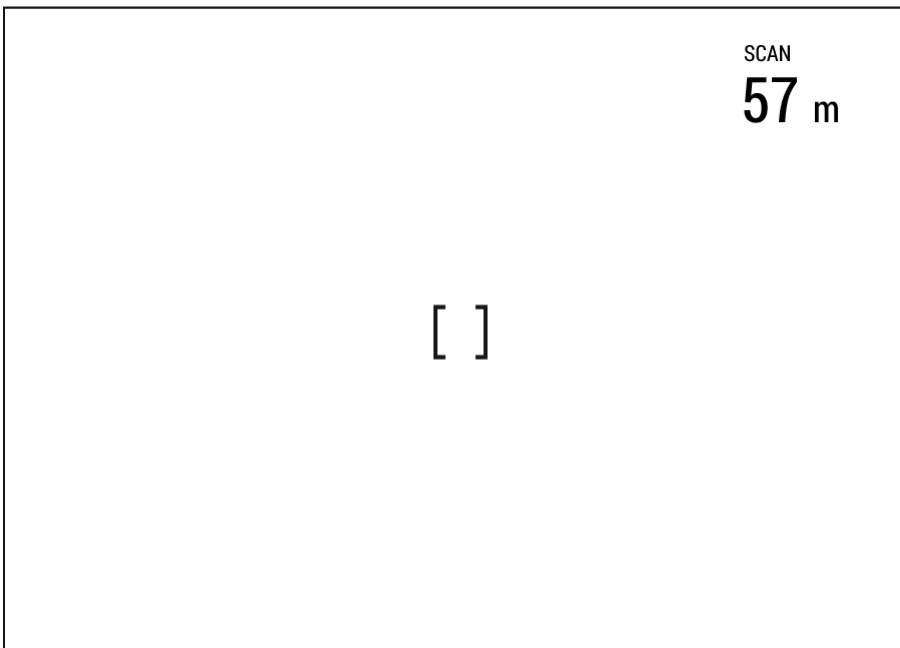

5. Deactivate the rangefinder by long pressing the **DOWN/LRF (12)**.

Notes:

- Additional rangefinder settings are available in the **Rangefinder** section of the main menu.
 - To select a unit of measurement (meters or yards) go to **Units of Measure**  subsection of the **General Settings** section.
 - When you turn on the rangefinder, the **PIP** window turns off.
-

Additional Information:

- The accuracy and distance of the measurement depends on the reflection coefficient of the object surface and weather conditions. The reflection coefficient depends on the texture, colour, size and shape of the object. Generally, lighter coloured objects and those with a shiny surface will have a higher reflection coefficient.
- Measurement accuracy can be influenced by the light conditions, fog, haze, rain, snow, etc. The results may be less accurate when operating in sunny weather or if the rangefinder is directed towards the sun.
- It is easier and more reliable to measure the distance to large objects than to small ones.

Digital Zoom

The functionality of the device makes it possible to smoothly increase the base magnification (please refer to the **Magnification** line in the **Specifications** table) of the device using the adjustment ring **(4)**, as well as return to the base magnification

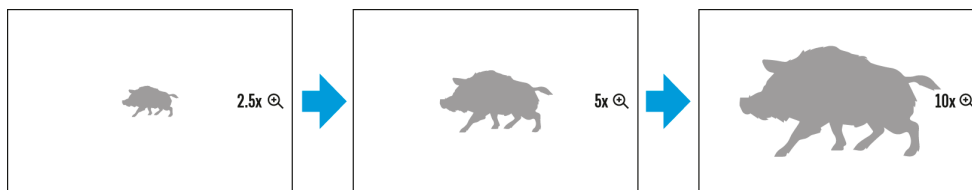

-
- To increase the digital zoom, turn the adjustment ring **(4)** clockwise.
 - To decrease the digital zoom, turn the adjustment ring **(4)** counterclockwise.

PiP Function

The **PiP** (Picture-in-Picture) function allows you to see both the main image and a magnified image in a dedicated window.

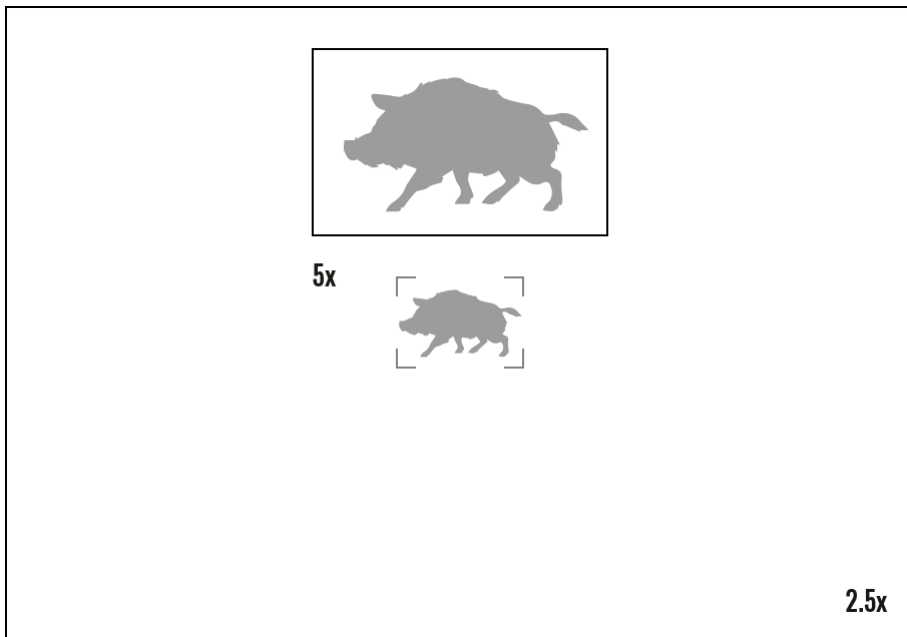

- To turn on and off the **PiP** function see the **PiP Mode** section.
- Rotate the adjustment ring **(4)** to change the magnification ratio in the **PiP**
- The zoomed image is displayed in a dedicated window, while the image in the rest of the screen is displayed at base magnification (2.5x).
- When the **PiP** is turned on you can control both the discrete and smooth digital zoom. In this case the zoom value changes only take place in the dedicated window.
- When the **PiP** function is turned off, the screen will display at the magnification that was set in **PiP** mode.

Display-Off Function

This function darkens the screen, which aids the user's concealment. However, the device stays on.

When this function is in use, the device switches to the standby mode, which allows it to be switched on instantly.

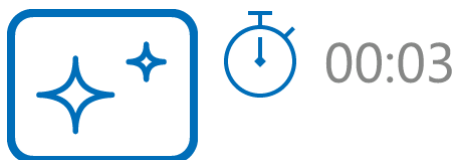

1. When the device is on, press and hold the **ON/OFF (9)** button. The display will turn off, the current time and the "**Display off**" icon will appear.





2. Turn the display back on with a short press of the **ON/OFF (9)** button.
3. When you press and hold the **ON/OFF (9)** button, the display shows the **"Display off"** icon with a countdown. Pressing & holding the button down for the duration of the countdown will power the device off completely.

Wi-Fi Function

The device has a function enabling wireless communication with external devices (smartphone or tablet) via Wi-Fi.

- Turn on the wireless module in the **Wi-Fi Activation**  menu option.

Wi-Fi is displayed in the status bar as follows:

| Indication on the status bar | Connection Status |
|---|---|
|  | Wi-Fi is switched off |
|  | Wi-Fi connection is in progress |
|  | Wi-Fi is switched on, no connection with device |
|  | Wi-Fi is switched on, device connected |

- The device is recognized by an external device as **TELOS_XXXX** where **XXXX** are the four last digits of the serial number.
- After entering the password (default: **12345678**) on a mobile device (see **Password Setup** subsection of the **Wi-Fi Settings** section for more information on setting a password) and setting up a
- The Wi-Fi function will turn off automatically if there is not enough battery power for Wi-Fi. The battery icon will turn red  and flash. To use the Wi-Fi function again, you need to charge the battery.

Installing the Device on a Tripod

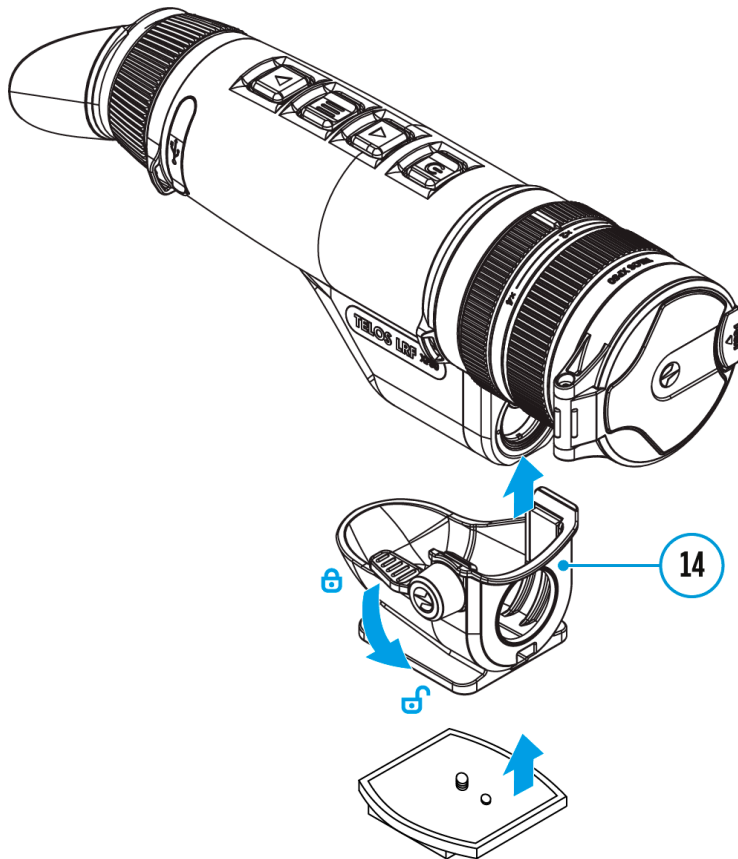

1. Screw the tripod adapter **(14)** (purchased separately) onto the tripod mounting plate until it stops.
2. Attach the mounting plate to the tripod.
3. Install the Telos LRF device into the tripod adapter **(14)** so that the rangefinder lens aligns with the hole on the front of the tripod adapter **(14)**.
4. Turn the handle of the tripod adapter **(14)** to position .

USB Connection

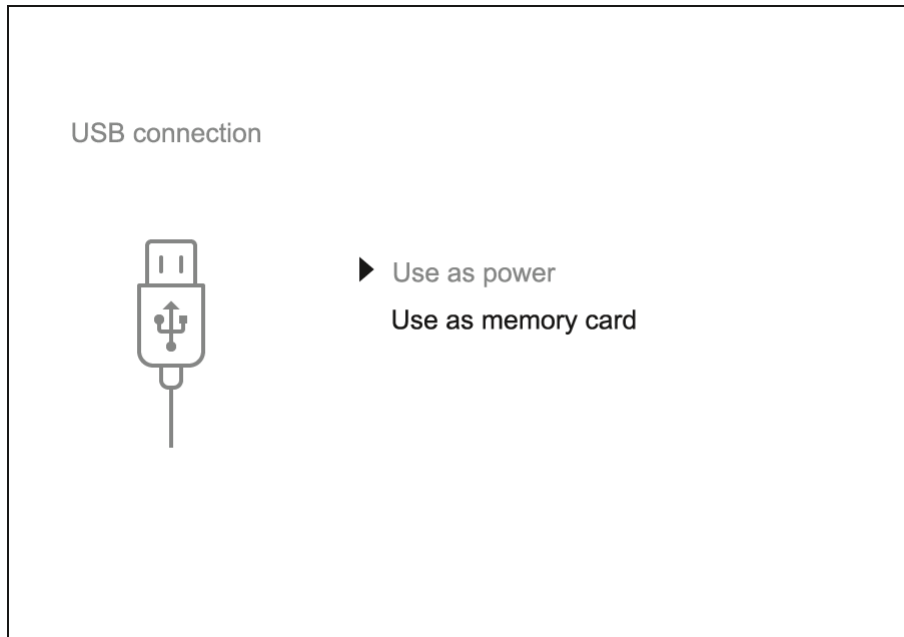

1. Connect one end of the USB cable to the USB Type-C port (**17**) of your device and the other end to the USB port of your PC / laptop using a USB Type-A adapter.
2. Turn the device on with a short press of the **ON/OFF (9)** button (a device that has been turned off cannot be detected by your computer).
3. Your device will be detected by the computer automatically; no drivers need to be installed.
4. Two connection modes will appear on the display: **Power** and **Memory Card** (external storage device).
5. Select the connection mode with the **UP (10)/DOWN (12)** buttons.
6. Confirm the selection with a short press of the **MENU (11)** button.

Power

- In this mode, a PC/laptop is used as an external power supply. The status bar shows the icon . The device continues operating and all functions are available.
- Battery recharge feasibility depends on your computer's USB port.
- When the USB is disconnected from the device when in the **Power** mode, the device keeps operating with the Battery Pack if it is available and sufficiently charged.

Memory Card (external memory)

- In this mode the device is detected by the computer as a flash card. This mode is designed for work with the files saved in the device's memory. The device's functions are not available in this mode; the device turns off automatically.
- If video recording was in progress when the connection was made, recording stops and the video is saved.
- If the device is in **Memory Card** mode and is disconnected from USB, the device will remain on.

Software

Stream Vision 2

Install the Stream Vision 2 application to download files, update firmware, control the device by remote control and broadcast images from your device to a smartphone or a tablet via WiFi.

We recommend using the latest version – Stream Vision 2.



You can find further guidelines on Stream Vision 2 [here](#).

[Download](#) from Google Play

[Download](#) from App Store

Find answers to frequently asked questions about using Stream Vision 2 [here](#).

Android

iOS

Firmware Update

1. Download the free Stream Vision 2 App in [Google Play](#) or [App Store](#).
2. Connect your Pulsar device to your mobile device (smartphone or tablet).
3. Launch Stream Vision 2 and go to section “Settings”.
4. Select your Pulsar device and press “Check firmware update”.
5. Wait for the update to download and install. Pulsar device will reboot and will be ready to operate.

Important:

- if your Pulsar device is connected to a phone or mobile device, please turn on mobile data transfer (GPRS/3G/4G) to download update;
- if your Pulsar device is not connected to your phone or mobile device but is already listed in “Settings” > “My devices” section, you may use Wi-Fi to download update.

Find answers to frequently asked questions about using Stream Vision 2 [here](#).

Is your firmware up to date?

Click [here](#) to check the latest firmware for your device.

Maintenance

Technical Inspection

It is recommended to inspect your riflescope before each use. Check the following:

- The device should be free of any cracks or deformations.
- The lenses should be free of cracks, grease, dirt or debris.
- The battery level of the device should be full. Electrical sockets should be free of salts, oxidation, or other debris.
- All controls should be responsive.

Technical Maintenance and Storage

Maintenance should be carried out at least twice a year and should include the following steps:

- Wipe the exterior surfaces of metal and plastic parts with a cotton cloth. Do not use chemically active substances, solvents, etc. as these will damage the paint.
- Clean the electrical contacts of the rechargeable battery on the device using a non-greasy organic solvent.
- Check lenses of objective, eyepiece and rangefinder. If necessary, remove dust and sand from the optics (it is preferable to use a non-contact method). Cleaning of the exterior surfaces of the optics should be done with cleaners designed especially for this purpose.
- Store the device in a carrying case. Remove the Battery Pack for long-term storage.

Troubleshooting

For technical support please contact support@pulsar-vision.com.

Answers to frequently asked questions about the devices can also be found in the **FAQ** section.

The device does not turn on

Possible cause

The battery is completely discharged.

Solution

Charge the battery.

The device does not operate from an external power source

Possible cause

The USB cable is damaged.

Solution

Replace the USB cable.

Possible cause

The external power supply is discharged.

Solution

Charge the external power supply (if necessary).

The image is blurry, with vertical stripes or an uneven background

Possible cause

Calibration is required.

Solution

Perform image calibration according to the **Calibration Mode** section of the manual.

Black screen after calibration

Solution

If the image does not clear after calibration, you need to recalibrate.

Poor quality image. There is noise or ghost images of previous scenes or objects

Possible cause

Manual calibration has been performed with the lens cover open.

Solution

Check the **Calibration Mode**, close the lens cover and calibrate the device.

Image is too dark

Possible cause

Brightness or contrast level is too low.

Solution

Adjust the brightness or contrast level in the **Quick Menu**.

Colour bars appear on the display or the image disappears

Possible cause

The device was exposed to static charges during operation.

Solution

When the exposure to static charges is over, the device may either reboot automatically or require to be switched off and on again.

The image of the object being observed is missing

Possible cause

The object is behind glass, which obstructs thermal vision.

Solution

Remove the glass.

Poor image quality / Detection range reduced

Possible cause

These problems may occur during observation in adverse weather conditions (snow, rain, fog, etc.).

The image quality during the device operation at below zero temperatures is worse than at positive temperatures

Possible cause

In warm climates, objects in the background of a thermal image heat up differently because of thermal conductivity, generating a high temperature contrast and a sharper thermal image.

In cold climates, objects in the background of a thermal image will cool down to roughly the same temperature, which leads to a greatly reduced temperature contrast and a degraded image quality. This is normal for all thermal imaging devices.

Smartphone or tablet PC cannot be connected to the device

Possible cause

Device password has been changed.

Solution

Delete the network and connect again using the password saved in the device.

Possible cause

The device is in an area with too many Wi-Fi networks that may be causing signal interference.

Solution

To ensure a stable Wi-Fi connection, relocate the device to an area with fewer or no Wi-Fi networks.

Possible cause

The device has a 5 GHz network enabled, but the smartphone only supports 2.4 GHz.

Solution

Switch the device's Wi-Fi bandwidth to 2.4 GHz.

More information on solving problems with connection to Stream Vision 2 by following the [link](#).

Wi-Fi signal is missing or interrupted

Possible cause

Smartphone or tablet is out of range of a strong Wi-Fi signal. There are obstacles between the device and the smartphone or tablet (e.g., concrete walls).

Solution

Relocate smartphone or tablet into the Wi-Fi signal line of sight.

More information on solving problems with connection to Stream Vision 2 by following the [link](#).

Rangefinder does not measure distance

Possible cause

There is an object in front of the receiver or emitter lens preventing signal transmission.

Solution

Make sure that: the lenses are not blocked by your hand or fingers; the lenses are clean.

Possible cause

The device is not being held steadily when measuring.

Solution

Keep the device steady when measuring.

Possible cause

Distance to the object exceeds 1000 m.

Solution

Pick an object at a distance not longer than 1000m.

Possible cause

Low reflection ratio (i.e. leaves of trees).

Solution

Pick an object with higher reflection ratio (see point **Additional Information** in section **Laser Rangefinder**).

Large measurement error

Possible cause

Inclement weather conditions (rain, mist, snow)

Legal Compliances and Disclaimers

Attention! A license is required for Telos Thermal Imager when exporting outside your country.

Electromagnetic compatibility. This product complies with the requirements of European standard EN 55032: 2015, Class A.

Warning! Operation of this equipment in a residential environment could cause radio interference.

Caution – use of controls or adjustments or performance of procedures other than those specified herein may result in hazardous radiation exposure.

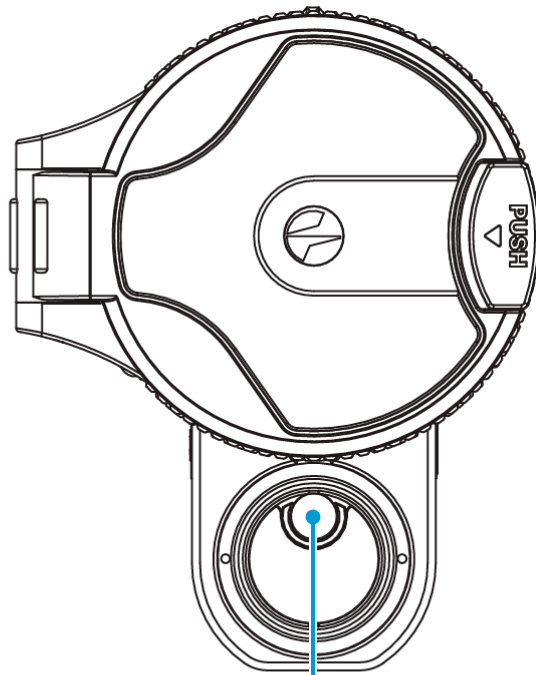

CLASS 1
LASER PRODUCT
BS / EN 60825-1: 2014

LRF Laser Aperture

The manufacturer reserves the right at any time, without mandatory notice, to make changes to the package contents, design and characteristics that do not impair the quality of the product.

Repair of the device is possible within 5 years.

